



G4 ICARUS Series 2

- Carbon and Sulfur Determination by Combustion

G4 ICARUS Series 2 – Outstanding Performance, Industry-proven Usability

Simultaneous carbon and sulfur analysis by combustion

The elemental content of carbon and sulfur within a material has a great impact on its physical properties. In steels, the carbon content determines properties like hardness, ductility, brittleness and magnetism and determines the actual grade of low alloy steels. Due to their impact on the material properties, carbon (C) and sulfur (S) are monitored along the whole production process. The need for fast and reliable CS analysis is not limited to iron and steel but also applies to ferrous and non-ferrous metals, their alloys, ceramics, ores, cement, limestone and numerous other inorganic solids.

Industry requirements

The quality control of industrial processes places high demands on analytical speed, stability and uptime, ease-of-use and maintenance. Versatility is an additional key requirement if sample matrices change each day like in a contract lab.

Combustion analysis with the G4 ICARUS Series 2 meets and exceeds all these demanding requirements. The combustion technique is known to be free of matrix effects, unbiased, accurate and fast. Combustion analysis is also used to confirm purity in incoming materials inspection due to its high speed and independence of sample mass. Even in difficult matrices like grey cast iron, where carbon is unevenly distributed in the form of graphite flakes, combustion analysis delivers accurate results because it is a volumetric method, analyzing the entire sample mass. This makes combustion analysis the reference method for precise and flexible carbon and sulfur determination.



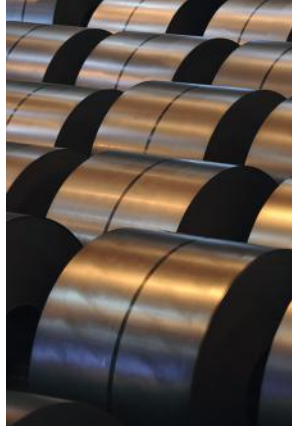

Principle

The solid sample, placed in a ceramic crucible together with accelerator material, is heated directly using a sealed high-frequency (HF) induction furnace. The molten sample is combusted in a flow of pure oxygen. The pressurized oxygen flow in combination with Bruker's unique ZoneProtect™ ensures a complete, clean combustion without undesirable side effects. During combustion carbon and sulfur components in the sample are converted into CO_2 and SO_2 . Traces of CO are oxidized downstream to CO_2 . These combustion gases are transported with the oxygen carrier gas for detection by advanced solid-state detectors.

A rapid and complete combustion process always creates residuals, especially oxide dust that builds up on affected parts of the combustion zone. Dust contaminants can trap or retain the liberated combustion gases, even if the combustion itself is complete. Hence a contaminated combustion chamber can adversely affect the results of subsequent analysis. This makes dust-handling a vital point, especially when trace level concentrations need to be determined.

The G4 ICARUS Series 2 avoids contaminations right from the start

Its entire flow path consists of chemically inert polymer tubing to avoid "hang-up" or "carry-over" effects and corrosion. The superior ZoneProtect delivers more precise analytical results in combination with increased productivity and cleanliness.

ZoneProtect™ – Clean, Fast & Efficient Combustion

Bruker's unique ZoneProtect design ensures a long lasting combustion tube and virtually eliminates any maintenance on this vital part. ZoneProtect further shields the entire combustion zone against splatters and dust deposits and supports a complete combustion. Unlike conventional designs operating with a lance, blowing oxygen over the sample or using proprietary high crucibles with slow combustion, the innovative principle of ZoneProtect knows no compromises.

The G4 ICARUS Series 2 with ZoneProtect™ combines speed and outstanding analytical performance with minimum maintenance

The ceramic crucible containing the sample and accelerator is positioned close below a gas extraction nozzle. The oxygen gas – needed for the combustion process – is supplied from the outside and flows through the annular flow gap formed between the crucible and extraction nozzle. This creates a vortex that ensures an optimal, surplus supply of oxygen to the molten sample. Liberated combustion gases and dust particles are instantly purged through the extraction nozzle, while its collar shields the quartz tube from splatters of the liquid sample. After the analysis, during the cleaning, the crucible acts as a waste bin. This unique construction leads to:

- More efficient, faster combustion on a wider variety of samples
- Superior gas flow: Instant removal of combustion gases without further dilution for fast and clean analysis
- Eliminating splatters and minimizing dust, thus maximizing productivity, component lifetime and analytical quality
- Vacuum- and noise-free dust removal system integrated into the combustion zone



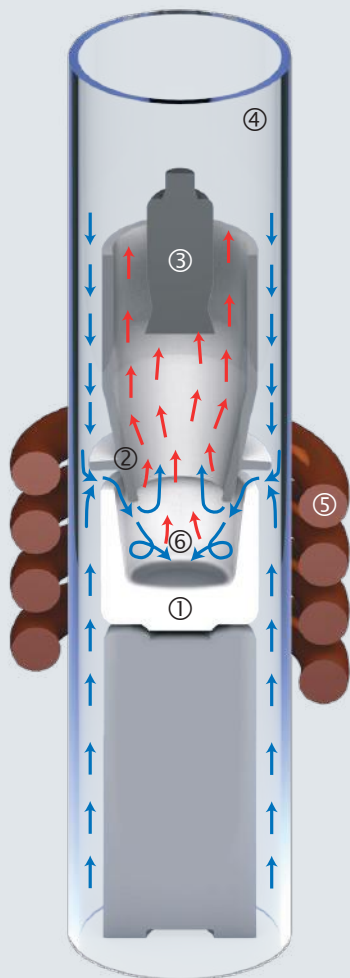

ZoneProtect (I)

- ① Ceramic crucible with sample and accelerator
- ② Gas extraction nozzle with collar
- ③ Tip of cleaning plunger
- ④ Quartz combustion tube
- ⑤ Induction coil of HF-furnace
- ⑥ Vortex of oxygen
- ⑦ High-efficiency dust filter

— Oxygen
— Combustion gases

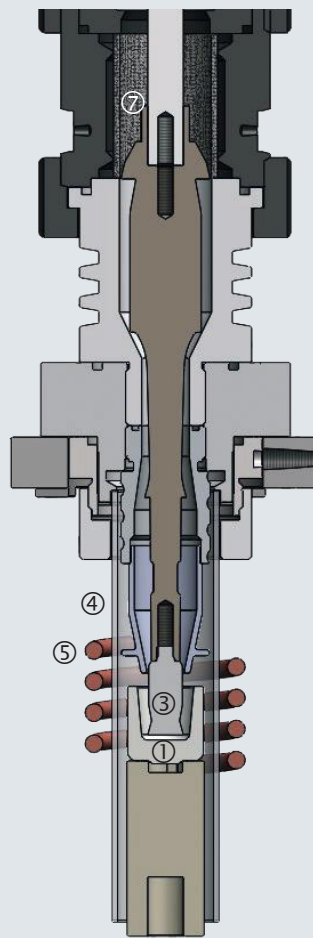

ZoneProtect (II)

The integrated and fully automatic cleaning system ensures a silent, fast and **vacuum-free** disposal of dust and splatters created during the combustion.

After the analysis the furnace remains closed and is depressurized through the temperature-stabilized, high-efficiency dust filter. The solid plunger, equipped with several wiper edges, secures simultaneous cleaning of the inline dust filter and the extraction nozzle. The plunger pushes the waste directly into the used crucible supported by a sweep of oxygen.

The unique ZoneProtect creates unrivaled performance with unmatched cycle times – purge, analysis and cleaning in below one minute.

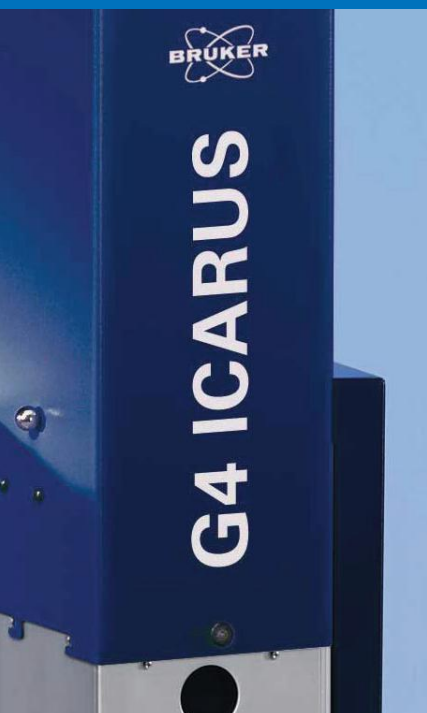

HighSense™: High-performance UV-Absorption for SO₂

The latest innovations in the field of high-performance light-emitting diodes (UV-LED), enabled the development of an SO₂ detector with outstanding performance. Non-dispersive UV absorption photometry (NDUV) utilizes electronic transitions within the molecules to measure the SO₂ concentration. As UV absorption is much more efficient than IR absorption, this results in lower detection limits suitable even for trace analysis. In addition, this kind of gas analysis is not affected by interferences of water molecules or thermal fluctuations. Operating the UV-LED under low power conditions ensures a typical lifetime of 10 years or more.

The new HighSense™ platform comes with a dedicated reference channel to eliminate drifts and provide baseline and calibration stability. The measuring cell is equipped with an inert coating to avoid "carry-over" effects and corrosion. The result is an SO₂ detector that outperforms the NDIR technique in every single aspect:

- 10 times better signal-to-noise ratio for highest sensitivity
- Drift-free baseline for long-term stability, not affected by temperature variations
- Ultra-wide linear dynamic range of 5 decades for application flexibility and easy calibration
- Staggering selectivity without any cross sensitivity to other combustion gases for accurate results
- Longest lifetime of light source for long-term stability with low operational costs

Combustion Gas

HF-induction furnace

Moisture Removal

Carrier Gas:
Pure Oxygen



Carrier Gas

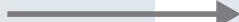

HF Furnace

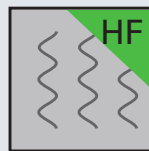

Sample

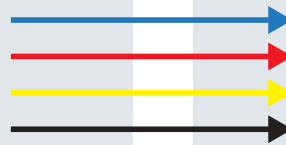

Remove moisture



- High precision, ultra-fast Mass Flow Controller (MFC) for absolute flow stability
- Adjustable purge and analysis flow rate for application flexibility
- Gas saving design with zero-flow in idle or stand-by mode
- Integrated carrier gas pre-cleaning
- Chemically inert flow path for high analytical precision, speed and corrosion resistance

- Advanced, power-adjustable HF-induction furnace with long-life oscillator tube and quiet cooling
- **High efficiency, integrated dust filter** with 3 μm pore size for a cleaner environment and improved stability
- Integrated viewport for direct observation of combustion process

ZoneProtect™

- Innovative **lance-free** furnace design with gas extraction nozzle for combustion without compromises
- **Vacuum-free** cleaning system with waste disposal into the crucible
- **Brush-free** cleaning operated by a solid plunger

Extra-long high-efficiency reagent tubes

- Efficient usage of reagents
- Flexibility for a mixed material packing without additional hardware (e.g. halide trap)
- Additional in-line membrane dryer available for hydrated samples

Particle filter inserts

- Protect delicate components from particles
- Act as reagent stop for easy maintenance
- Laminar flow element for high fluidic precision

HighSense™ Detector (NDUV)

Catalytic Conversion

Nondispersive Infrared Detector (NDIR)



1:1 Carbon
**Utmost
selectivity**



high ng/g (ppb) to %

high ng/g (ppb) to %

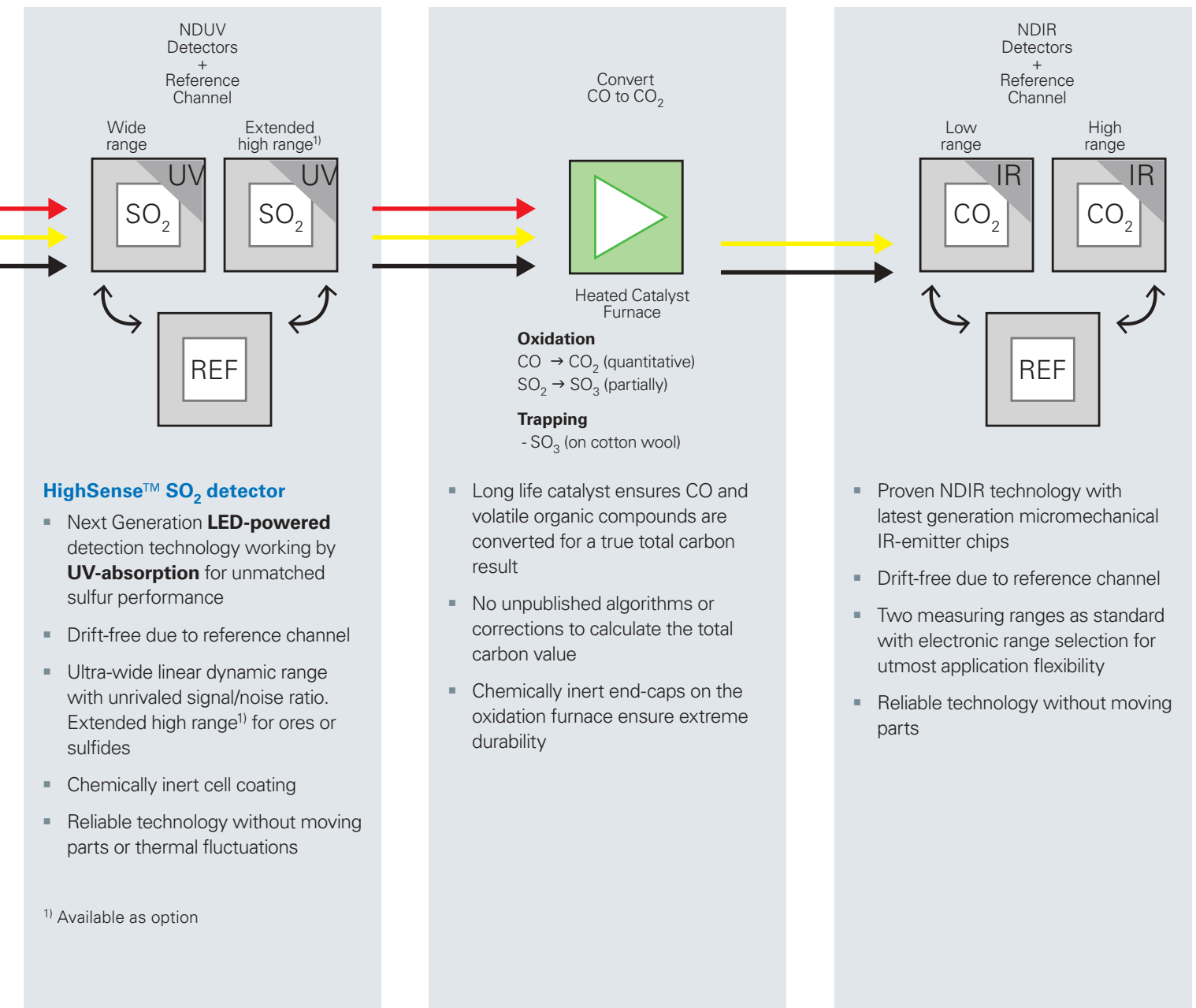

Overview of Features and Benefits

	Specification	Benefit
Samples		
Sample Types	Inorganic, dry, any form or shape	Flexibility
Typical Samples	Ferrous and nonferrous metals and their alloys, ores, cement, limestone, glass, ceramics, soils	Wide variety of sample materials
Sample carrier	Ceramic crucibles (standard form)	Usage of industry standard consumables, lower cost, security of supply
Sample weight	0.1 – 1 g (typical 0.5 g)	
Furnace	High frequency induction furnace, power adjustable with ZoneProtect™	More efficient, faster combustion with maximum productivity
Detectors		
Sulfur	HighSense™ NDUV ²⁾ detector with reference beam path	Unique wide range performance with unrivaled signal/noise without drift
Carbon	Dual-range NDIR detector with reference beam path	Reliable, maintenance-free performance without drift
Carrier Gas	Oxygen 99.95% purity (99.995% required for trace carbon) 3.5 bar (50 psi) min. pressure	Standard gas purity sufficient
Compressed air	5 bar (72.5 psi) min. pressure, oil-, water- and particle-free	
Speed		
Analysis Time	40 s (nominal)	Fast, simultaneous analysis
Complete Cycle Time	< 1 min (typical)	High productivity and throughput with waste disposal into crucible
Noise Emission	< 50 db	Enjoy the silence
Calibration	Single and multipoint calibration with solid standards	
Reagents	<ul style="list-style-type: none"> • Magnesium perchlorate • Sodium hydroxide on support • Platinized silica 	
Power Supply	230 VAC (± 10 %); L1 N; 208 VAC (± 10 %); L1 L2;	50-60 Hz; 16 A; 2.7 kVA Industry standard power and current configurations

²⁾ NDIR-based detector available on request

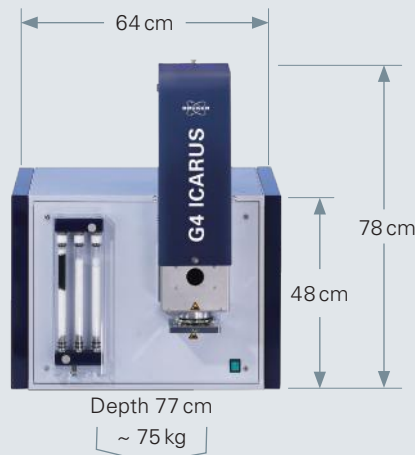

Bruker AXS GmbH
info.baxs@bruker.com

Worldwide offices
bruker.com/baxs-offices

Online information
www.bruker.com/g4icarus

www.bruker.com

